

PRINT & ASSEMBLY GUIDE v20

3D PRINTED DESK SHELF

3DP-DS-1



TABLE OF CONTENTS



01	<u>How to Use This STL Pack</u>	3
02	<u>General Printing Guidelines</u>	4
03	<u>Desk Shelf Setup</u>	
	<u>Test Parts</u>	5
	<u>Legs, End Caps & Shims</u>	6
	<u>Covers, Shelves, & Stops</u>	8
	<u>Corner System</u>	11
	<u>Dowel Spacer</u>	12
04	<u>Desk Shelf Add-Ons</u>	
	<u>MagSafe Mount</u>	13
	<u>Headphone Stands</u>	16
	<u>Tablet/Phone Mount</u>	17
	<u>Speaker Stand</u>	19
	<u>Laptop Stand</u>	21
	<u>Laptop Stand Extension</u>	27
	<u>Laptop Brackets</u>	29
	<u>Vertical Laptop Stand</u>	31
	<u>Drawers</u>	34
	<u>Twist Lock System</u>	38
	Pencil Cup, Cup Holder	
	Coaster, Sticky Notes Holder	
	<u>Cable Organizers</u>	39
	<u>Bookends</u>	40
	<u>Watch Charger</u>	41
	<u>Watch Stand</u>	43
	<u>Controller Mount</u>	44
	<u>Threaded Accessory Mounts</u>	46
	<u>Glasses Holder</u>	48
	<u>DeskRail System Adapters</u>	49
	<u>Bambu LED Lamp Mount</u>	52

HOW TO USE THIS STL PACK



Thank you for purchasing the Desk Shelf System STL Pack!

This manual is here to help you easily find, print, and assemble every part of the Desk Shelf system.

To get started, use the Table of Contents (TOC) to jump to the model you'd like to print. You can quickly navigate to the TOC using the link at the bottom right corner of each page.

If this is your first time building the shelf, begin with the **Desk Shelf Setup in Section 3**. Each part page includes the file path, print orientation, helpful print notes, and assembly steps as needed.

To download the latest version of the STL pack at any time, simply login to shop.theworkspacehero.com using the email you purchased with.

Requirements

- Wooden Dowels, 7/8" (22mm), 21mm, or 20mm diameter @ desired length
 - 5x dowels for the Small Desk Shelf, 6x dowels for the Large Desk Shelf
- 10mm diameter adhesive rubber feet*
- Super Glue* (used for specific add-ons)

[*Up-to-date links can be found on the website product listing.](#)

Understanding Each Part Page

Each part page will have an image of what the part looks like, a description of what it does, the location of the file in the STL pack, the required print orientation, and images of the assembly process as necessary.

Because this STL pack has multiple size variations, many file paths will include 'X' as a placeholder. Select the variation of your choice when navigating through the STL pack.

Example of File Path:

DeskShelf STL Pack X mm > X (Legs-Shelves) > Legs - X Height

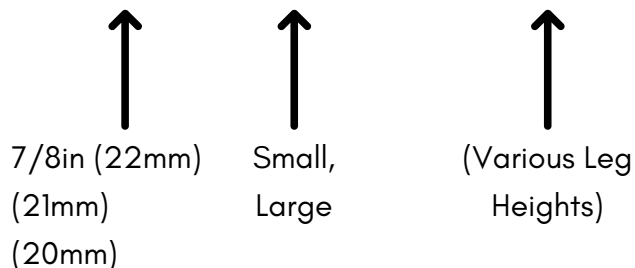

Video Links

This icon is a clickable YouTube link to a related short video of the part or assembly. These can be helpful to visualize the parts being used or assembled onto a desk shelf.

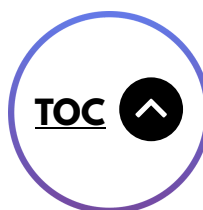

Table of Contents Link

This icon is a clickable link that takes you back to the Table of Contents for quick navigating.



GENERAL PRINTING GUIDELINES



General Settings:

Unless otherwise specified, these models are designed to be printed with PLA, and using the following general printer settings:

Nozzle Diameter: 0.4mm

Layer Height: 0.2mm

Infill: 15%

Some tolerances can be tight, so using a calibrated printer and filament is important. Light bridging is required with parts in this STL pack.

Supports are not required unless otherwise specified.

If you have a small 3D printer (A1 Mini or similar), use the Small Desk Shelf variation. Standard (10"x10") 3D printers can print both the Small and Large Desk Shelf sizes. The Small Desk Shelf uses 5x wooden dowels, and the Large Shelf uses 6x wooden dowels.

TEST PARTS

The test prints emulate the geometry of the dowel holes and the dovetail grooves in the legs, as well as the dovetail on the shelves. Printing these smaller models can help you confirm your printer and filament settings before printing the full size models.

When printing the **Shelf Dovetail Test Print**, use the recommended painted Brim Ears mentioned with the Shelf print instructions (page 8).

The Dowel Fit Test Prints have the Left/Right Leg Dowel holes with the tapered teeth that hold your dowels in place. (You can use dowel shims if your dowel ends are slightly undersized.)

File Path:

DeskShelf STL Pack > Test Prints

Print Orientation:

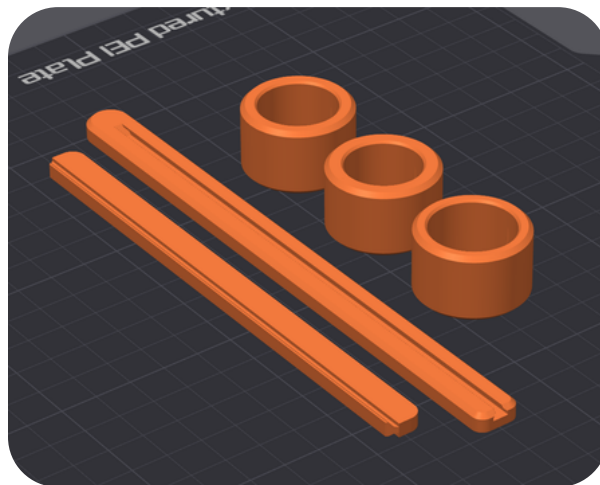

LEGS, END CAPS, & SHIMS

There are multiple variations of the DeskShelf legs. The Large size uses 6x dowels (8.2 inches deep), and the Small size uses 5x dowels (6.8 inches deep).

The Left & Right Legs have teeth in each of the dowel holes that grip the wooden dowels. If your dowels are undersized at the ends, you can use the Dowel Shims to get a firm press-fit into the Left and Right Legs.

If you plan on using the Corner System, they have their own legs (covered on page 11). End Caps have the same teeth that grip the wooden dowels, and can conceal exposed dowel ends. End caps can help build your shelf around your monitor arm.

There are three leg heights to choose from within each collection:

Large: 3.4, 4.4, & 5.4 inches

Small: 3.0, 4.0, & 5.0 inches

File Path:

Legs: DeskShelf STL Pack > X (Legs-Shelves) > Legs - X Height

End Caps: DeskShelf STL Pack > Attachments > End Caps

Shims: DeskShelf STL Pack > Dowel Shim

Print Orientation:

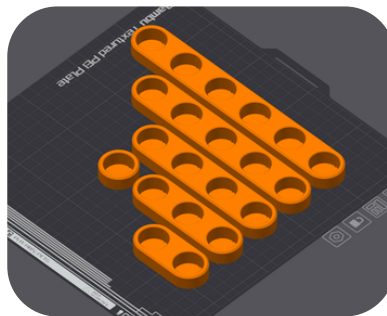
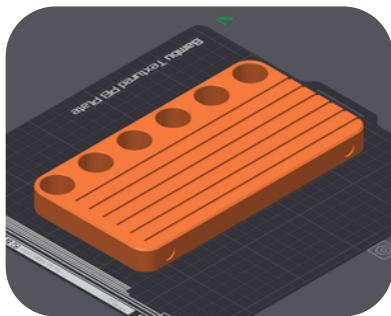

Assembly Steps

Step 1:

The Legs and Shelves have dovetail grooves running along the sides, starting from the back and stopping just before the front face. This is intentional – it keeps the front of the shelf clean and seamless when assembled, and only allows dovetail access from the back. Ensure all parts are assembled with this orientation in mind.



FRONT OF
DESK SHELF

Step 2:

Place the Right Leg on a flat surface, and install all wooden dowels. There should be slight resistance as you push the dowels into the leg. Install all dowels firmly. If the dowel ends are too loose, use a Dowel Shim to get a proper press-fit.



Using the Dowel Shims

To use the Dowel Shims, bend the tabs to roughly form a 90 degree angle, wrap the shim around the Dowel, and install the dowel.



Step 3:

Once all dowels are firmly installed, insert the Middle Leg from above. After these two legs are installed, place the desk shelf flat on your table. If your dowels are oversized or not completely straight, it may be easier to install dowels one at a time. (Steps are continued in the Cover/Shelf Section.)



COVERS, SHELVES, & DOVETAIL STOPS

The Covers and Sub-Shelves come in matching widths so they can be paired together. The Covers conceal the dowels and space two Legs apart at the correct distance so a matching shelf width can be installed.

The Legs and the Shelves have dovetail grooves, and the Stops can be used in these channels for various purposes. The End Stops lock the shelves in place (as seen in the assembly steps below).

File Path:

Covers: DeskShelf STL Pack > Top Covers

Shelves: DeskShelf STL Pack > X (Legs-Shelves) > Shelves

Stops: DeskShelf STL Pack > Attachments > Dovetail Stops

Print Orientation:

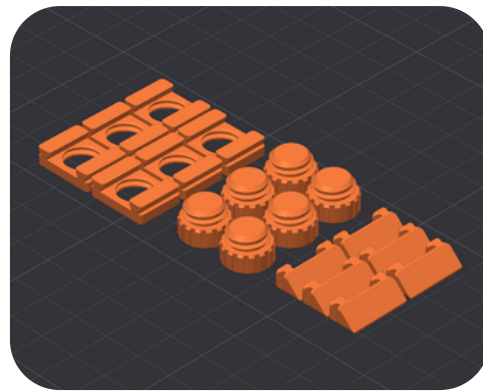
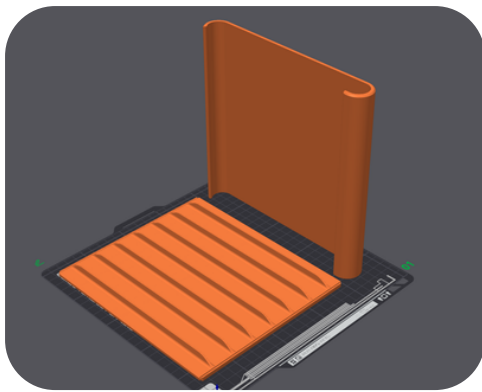

For the best adhesion on the Shelf's dovetail edges, **add painted brim ears on each corner of the shelf as shown below.** (In BambuSlicer Others > Brim Type > Painted, Select Brim Ears on top toolbar, click on corner of Shelf to add a Brim Ear).

These can be used on the Covers as well if bed adhesion is an issue.

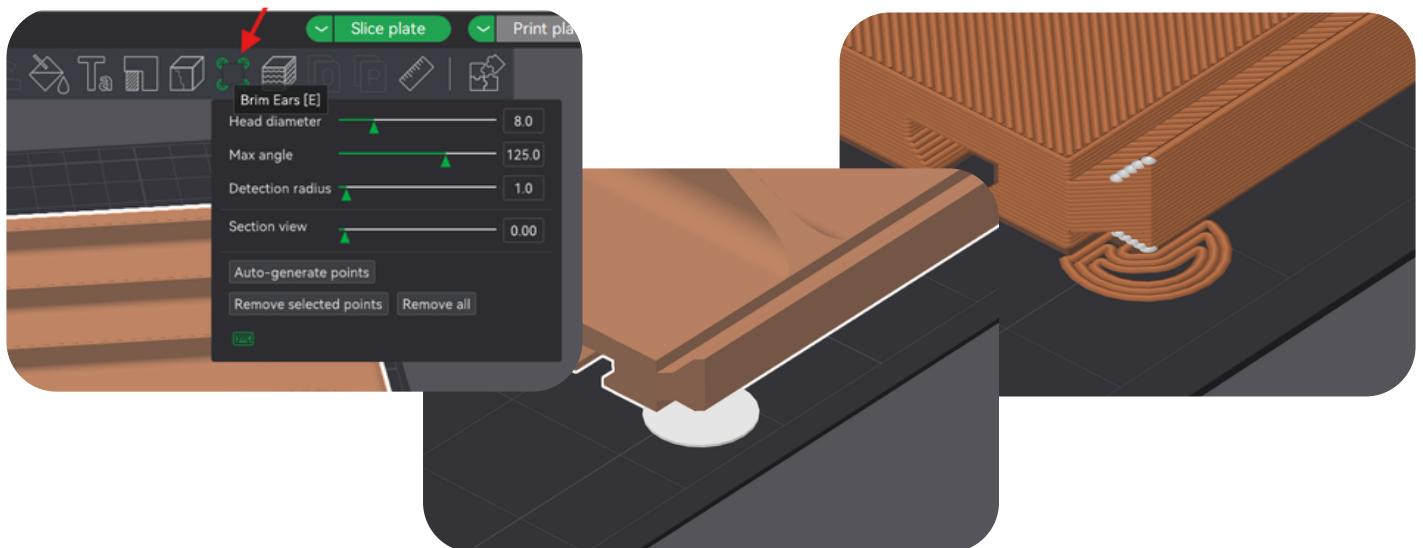

Assembly Steps

Step 1:

Hook the front arc of the cover onto the first dowel and press the back of the cover onto the rear dowel to *snap* into place. The cover can slide on from the free end of the dowels as well.



Step 2:

Move the legs to meet either side of the Cover. This controls the distance between the legs which allows a smooth install of the Shelf.



Step 3:

Install the Shelf into the Legs at the desired height. Ensure you install both ends of the Shelf at the same height to avoid damaging the Shelf or the Legs. Once the Shelf is installed, use an End Stop to secure the Shelf in place.

The End Stop can slide along any of the dovetail surfaces (Legs & Shelf) to keep the shelf in place, or to keep items like your docking station from moving when placed on the Shelf.



Step 4:

Lastly, install the 10mm adhesive back feet on each of the legs.



CORNER SYSTEM

To use the Corner System, print both Corner Legs of your chosen size along with the Top Plate and Bottom Plate. All four parts are required to use the 30/45/60/90 degree angle plate adapter.



File Path:

Desk Shelf STL Pack > X (Legs-Shelves) > X Height Corner Legs

Print Orientation:

Adding Brim Ears as mentioned in the Shelf section previously (page 8) is recommended with the Corner Top Plate and Corner Bottom Plate dovetail corners.

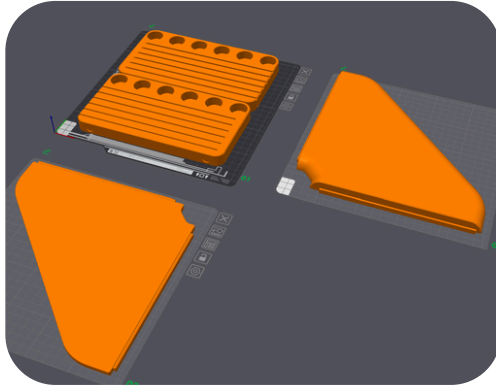

Assembly Steps:

Insert the plates into the side of the leg with two dovetail slots as shown below. Ensure the bottom plate is installed closest to the bottom of the legs. The plates will audibly *snap* into place.



DOWEL SPACER



Use this Dowel Spacer to control the distance between dowels in long, unsupported sections of your Desk Shelf.

Unrestrained dowels can flex under load, reducing how securely certain add-ons attach. This spacer controls the spacing between dowels, minimizing flex, and improving add-on fitment and stability. Only use as needed.

File Path:

Desk Shelf STL Pack > Attachments > Dowel Spacer (Upper & Lower).stl

Print Orientation:

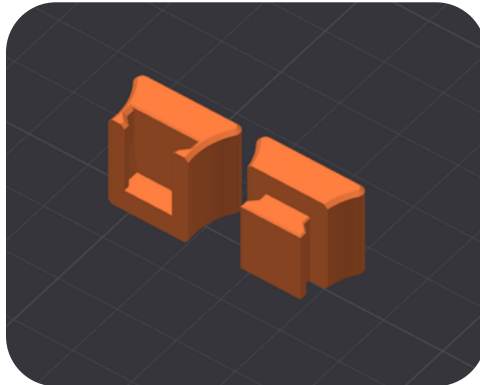

MAGSAFE MOUNT



There are five variations of wireless chargers for phones in this “MagSafe Mount” folder, including the Apple Gen 1 and Gen 2 MagSafe Charger, the Google PixelSnap Charger, and the Anker Zolo Qi2 Wireless Charger. The last variation is a universal mount that uses an adhesive pad for any flat bottomed wireless charger.

File Path:

Desk Shelf STL Pack > Attachments > MagSafe Mount

Print Orientation:

If you are using the Universal mount, supports are optional on the Puck Holder. Other MagSafe models do not require supports.

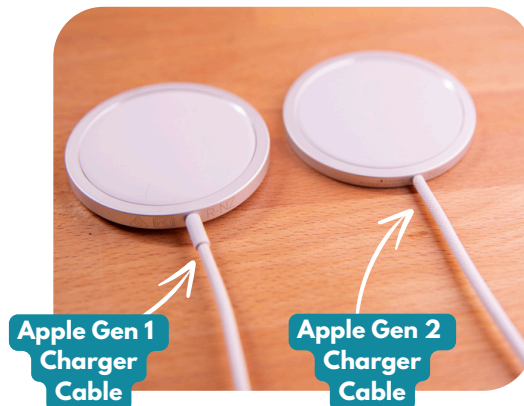
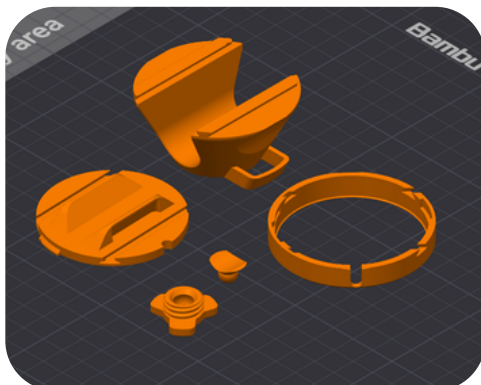

Assembly Steps



Step 1:

First, press the Screw Insert into the Screw, as shown below. The fitting will *snap* into place and should loosely move around. Install this screw into the Dowel Mount



Step 2:

Place your charging puck inside of the Puck Housing. Ensure the front of the charging puck meets the front lip as shown below. Avoid installing the charger at an angle.



Step 3:

Assemble the Puck Clamp onto the back of the Puck Housing. Twist into place and the two mounts should lightly *snap* into place. **The cable exit notch must line up on both the Puck Clamp and the Puck housing.**



Step 4:

Assemble the Dowel Mount onto your dowel. Depending on the charger, you may have to install this at a slight angle.

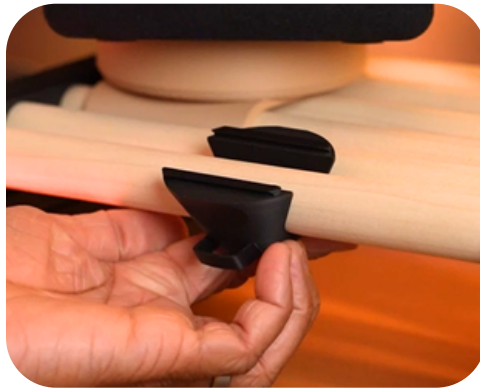

Step 5:

Ensure both dovetails line up together, and slide the two parts together, they will *snap* into place. Finally, tighten the Screw to hold your charger in place at the desired level.



Universal Charger

If using the Universal Charger, skip Steps 2 and 3. Simply add an adhesive pad* (20mm diameter x 0.5mm thick) to the Puck Holder, install your desired charger, and continue with Steps 4 and 5.

*Up to date links can be found on the [Desk Shelf Product Listing](#).



HEADPHONE STAND



There are multiple variations of the headphone stand. Front Facing stands present your headphones to you, and Side Facing Stands are more space efficient. Each headphone stand comes in three different sizes, standard, XL, and XXL.

All stands also come in a two-part variation to fit on smaller 3D print beds. The two-part versions simply snap together (glue may be required based on your printer tolerances), and all versions snap onto the desk shelf dowels.

The different sizes have a different height and width of the headband platform. See the approximate dimensions below to choose the appropriate headphone stand.

SIZE	HEIGHT (in)	HEADBAND WIDTH (in)
STANDARD	8.5	1.50
XL	9.5	1.75
XXL	9.5	2.25

File Path:

Desk Shelf STL Pack > Attachments > Headphone Stand > Side Facing, Front Facing

Print Orientation:

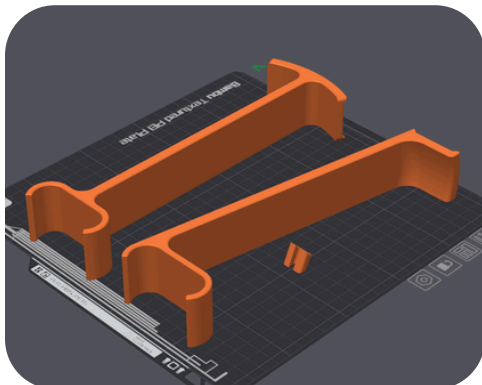

Full Size Versions

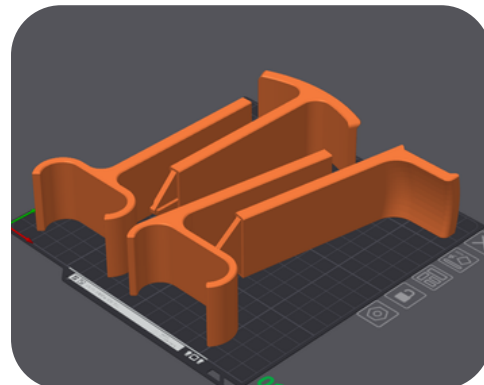

Two-Part Versions

TABLET-PHONE MOUNT



This tablet/phone mount allows you to display your devices on your desk shelf and swivel them to a desired angle. There are two front plates to choose from, the larger size is for tablets, and the smaller size is for phones. There are three angles to choose from as well, 15°, 30°, and 45°.



File Path:

Desk Shelf STL Pack > Attachments > Phone-Tablet Holder

Print Orientation:

The Base, Tablet Mount, and Phone mount components require tree supports on the build plate, as shown below.

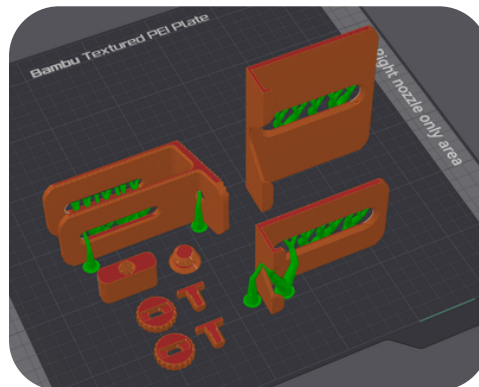

Assembly Steps

Step 1:

First, assemble the two rear screws. Insert the Rear Screw-Thread into the Rear-Screw Knob. There should be a light press fit that holds the two parts together.



Step 2:

Install the Spacer between the first two dowels of your desk shelf as shown below. Slide the Base onto the dowels and align the slot of the Base with the threaded hole of the Spacer.



Step 3:

Install the two Rear Screws, one from the top, and one from the bottom. Both the top and bottom screws need to be tightened/loosened together when fixing or moving the mount. Lastly, install the phone holder or tablet holder front plate and tighten the Front Screw to hold it in place (do not overtighten).

(The Key used in this mount is the same key used in the Laptop Stand and the Speaker Stand.)

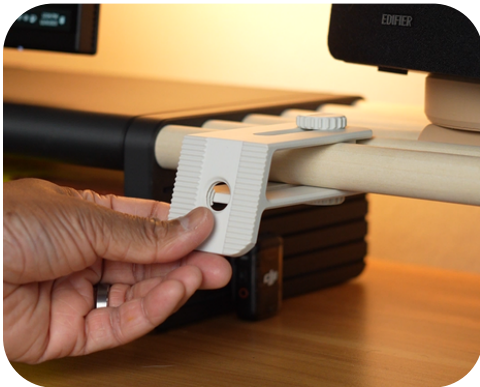

SPEAKER STAND



The Speaker Stand mount has a platform that is 5.5 inches deep and 4 inches wide. They can swivel freely, or can be locked into a specific angle using the Indexer.



File Path:

Desk Shelf STL Pack > Attachments > Speaker Stand

Print Orientation:

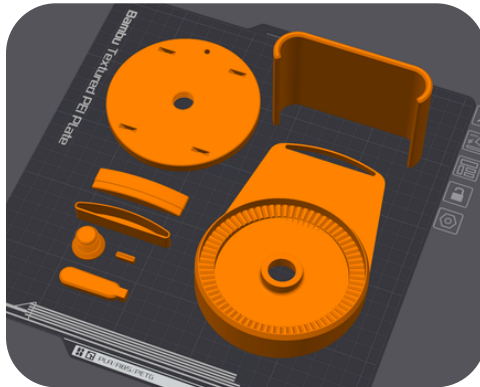

Assembly Steps

Step 1:

First, apply glue to the four tabs on the Dowel Clamp. Align the tabs with the Turntable and press the two parts together, ensure the glue is making contact with both parts. Let the glue dry before using this component.

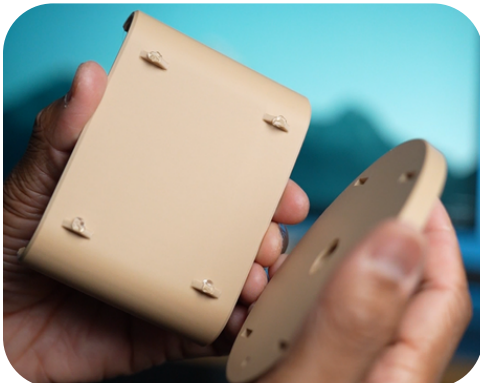

Step 2:

Install the Front Lip, followed by the Front Lip Cover. Use glue if necessary.



Step 3:

If a fixed position is desired, install the small Indexer to the Turntable (optional). Place the Speaker Stand on top of the Turntable and rotate the stand to the desired angle.

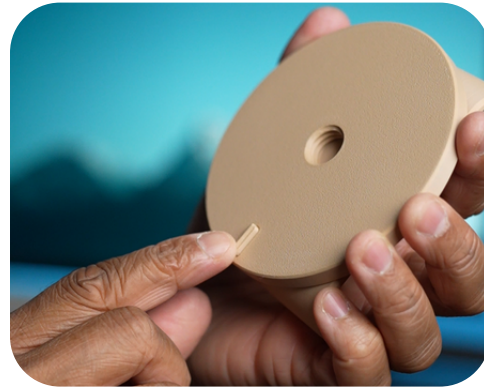

Step 4:

Using the Key, tighten the Screw to fix the Speaker Stand to the Turntable. Do not overtighten.

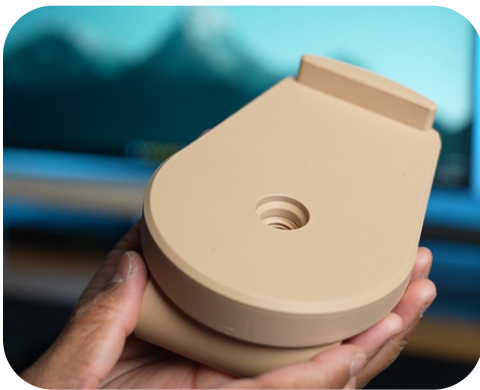

LAPTOP STAND



There are two main versions of the laptop stand. Version 1 (V1) is a 'Y' shaped stand which works best for smaller laptops. A small-printer version of this 'Y' stand is included as well where the legs are assembled separately.

Version 2 (V2) is an 'X' shaped laptop stand that is larger, stronger and has the option to outfit extended arms for bigger laptops.

File Path:

Desk Shelf STL Pack > Attachments > Laptop Stand

Print Orientation:

The single piece V1 Laptop stand does not require supports. The Laptop Stand Core for the small-printer V1 and V2 require standard supports on the build plate only.

Version 1
Laptop
Stand

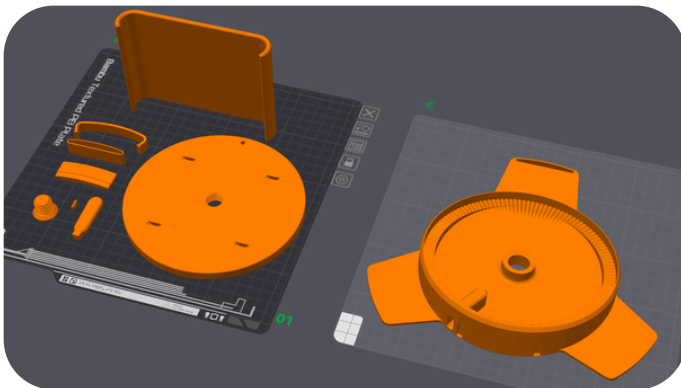

Small-Printer
Version 1
Laptop
Stand Core

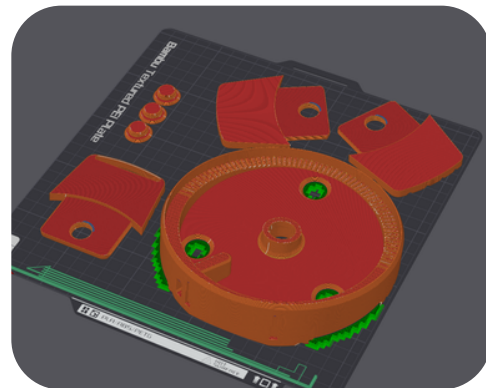

Version 2
Laptop
Stand

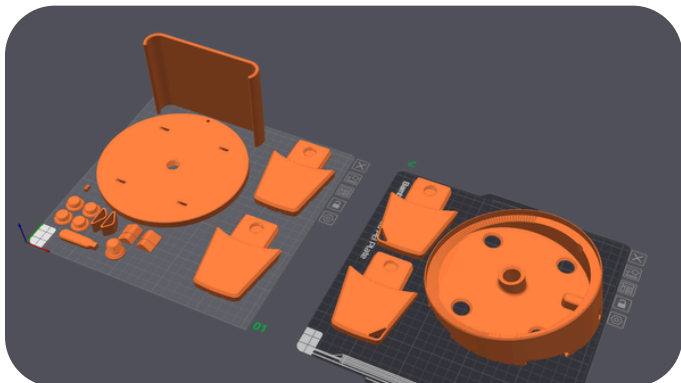

Version 2
Laptop
Stand

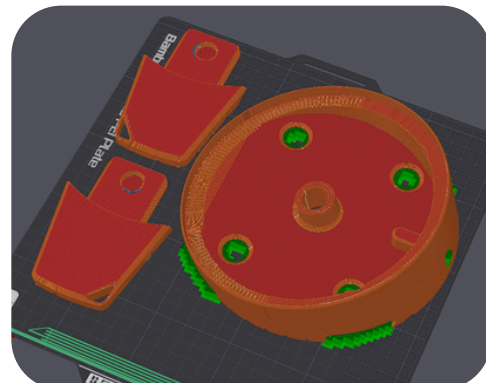

Size Comparison:

See the supported area dimensions for the three different sized laptop stands below. Consider your laptop size and desired functional features to select which laptop stand is best for you.

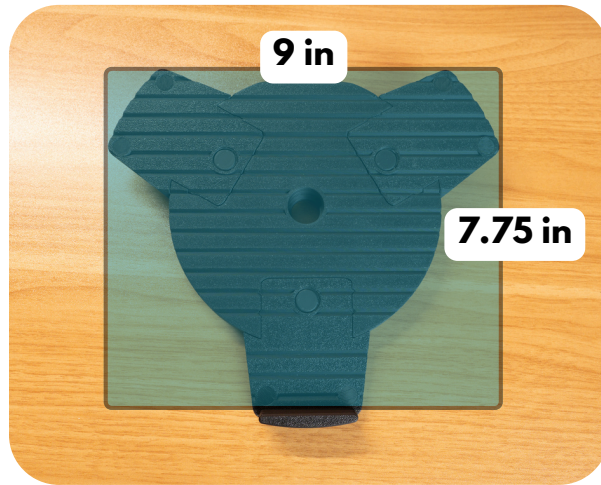

Version 1

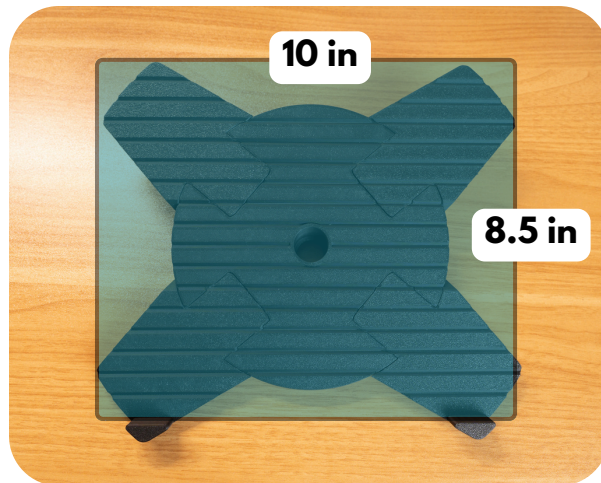

Version 2 - Standard Legs

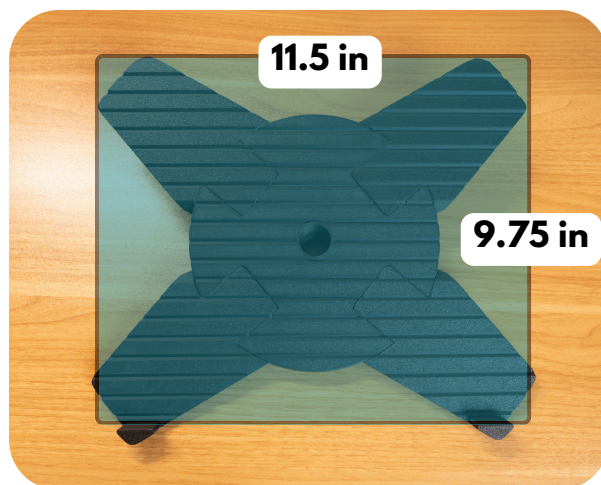

Version 2 - Extended Legs

Version 1 Assembly Steps



Step 1:

Apply glue to the four tabs on the Dowel Clamp. Align the tabs with the Turntable Base and press the two parts together, ensure the glue is making contact with both parts.

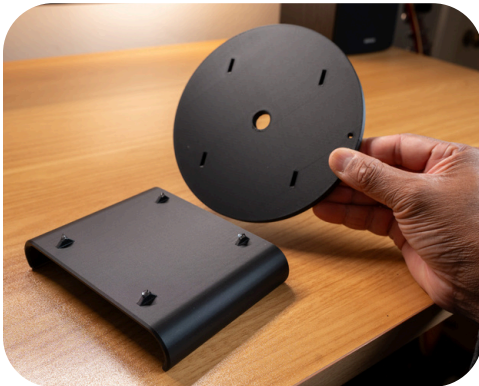
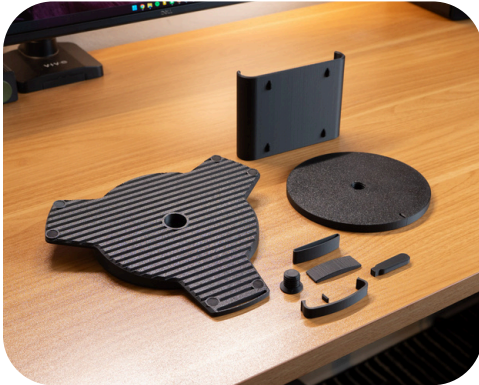

Step 2:

If a fixed position is desired, install the small Indexing Tab to the Turntable Base (optional). Place the Laptop Stand Swivel on top of the Turntable Base. Rotate the stand to the desired angle. Using the Key, tighten the center Screw to fix the Laptop Stand to the Turntable Base. Do not overtighten.

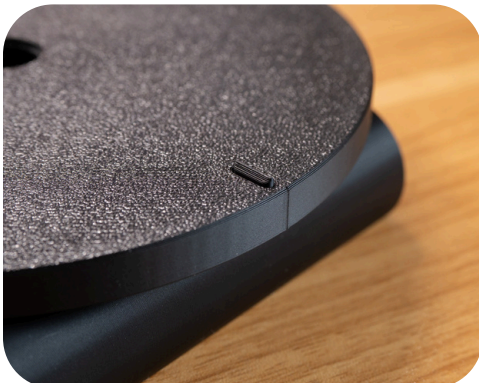

Step 3:

Install the Front Lip, followed by the Front Lip Cover. Use glue if necessary. The Key can be stored at the back of the Laptop Stand. The Cable Clip slides into the two grooves in the rear of the mount to ensure you cables have a controlled exit from the stand.

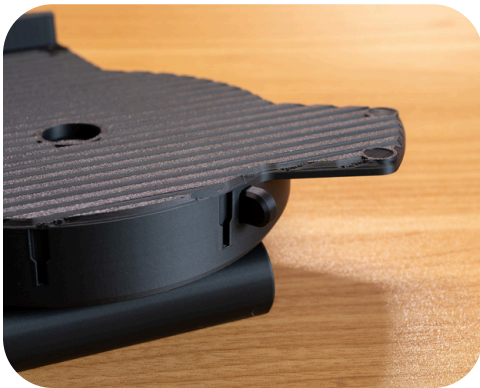
**Step 4:**

(Optional) Add 10mm adhesive rubber bumpers to the top of the stand at the indicated locations. The two rear bumpers are sufficient, however, you can install all six for maximum grip.

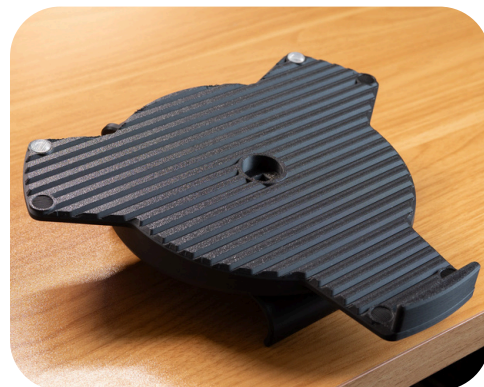

Step 5: (For the Small-Printer Version 1 Laptop Stand)

Simply slide in each of the Legs into the Laptop Stand Core. The lines on the Legs should match the lines on the Laptop Stand Core. Then, use the Leg Screws to fasten the legs in place from the underside of the Laptop Stand Core.

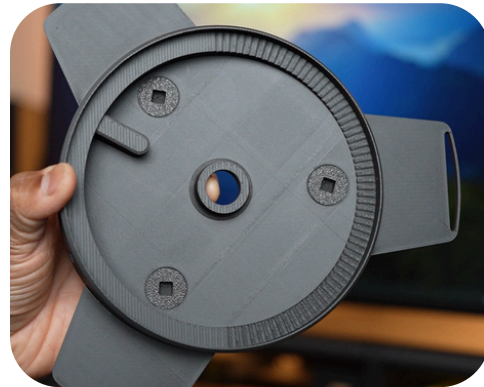
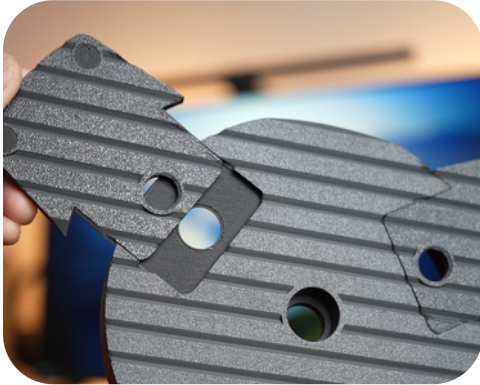

Version 2 Assembly Steps

Step 1:

Follow Step 1 from Version 1 above: glue the Dowel Base to the Turntable Base. Next, install the legs onto the Laptop Stand Core and fasten them in place using the Leg Screws from the inside.



Step 2:

Install the Left and Right Lips into the Lower Left and Lower Right Legs. Then conceal the Lips using the Left and Right Lip Covers. Use glue if necessary.

**Step 3:**

Install the Dowel Base/Turntable Base onto your desk shelf. Use the indexing tab on the turntable base to lock the angle of your Laptop Stand (optional). Place the Laptop Stand Core assembly on top of the Turntable Base, and fasten in place with the Center Screw. Do not overtighten.



LAPTOP STAND - EXTENSION



If the standard laptop stand sets your laptop screen too far back, you can use this forward extension which brings the laptop stand forward.

Note: this attachment moves your laptop's center of gravity forward and risks tipping forwards if there is not sufficient weight on your Desk Shelf. Consider your setup, test, and use at your own risk.

When printing the files, choose the correct turntable base. Version 1 (Y-shape) and Version 2 (X-shape) have different diameter bases.

File Path:

Desk Shelf STL Pack > Attachments > Laptop Stand > Forward Extension

Print Orientation:

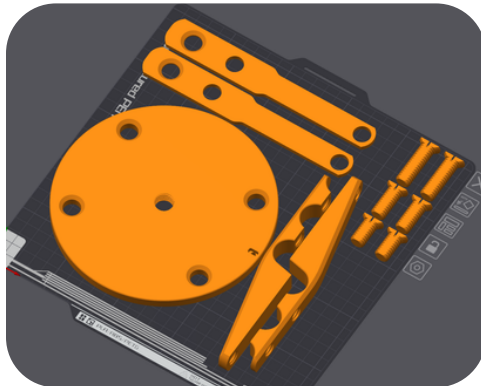

Assembly Steps

Step 1:

Assemble the two Dowel Clamp Bases and Dowel Clamp Tops onto your shelf as shown below and loosely install the Rear Screw (medium length screw) onto each. The Clamps should be free to slide along the dowels.



Step 2:

Place the new Turntable Base on top, and adjust the Dowel Clamps to ensure all four holes line up with the Turntable Base. The front of the Turntable base has the small indexing hole. (Use the same key found the Laptop Stand folder).

Install the Front Screws (shortest screw), and the Middle Screws (longest screw) once all the holes are lined up. The Front and Middle screws should go through all three parts: the Turntable, Clamp Top, and Clamp Base. Ensure all screw are snugly fit.

You can now install the laptop stand using the center screw as shown in the Laptop Stand assembly steps.



LAPTOP BRACKETS



The Laptop Brackets are simple assemblies that can hold your laptop on either end and attach directly underneath the dowels. They come in two different depths: 1.5 inch and 2.0 inch.

Each bracket assembly requires printing 1x Wall, 1x Platform, 2x Platform Screws, 3x Top Clamps, and 3x Top Clamp Screws.

You can also use the Dovetail Laptop Bracket which slides onto a Leg instead and can be fixed in place using two End Stops (Desk Shelf STL Pack > Attachments > End Stops).

File Path:

Desk Shelf STL Pack > Attachments > Laptop Brackets

Print Orientation:

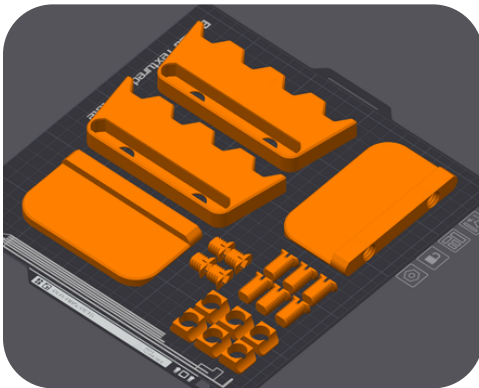

**1.5 inch Wall
Laptop Bracket**

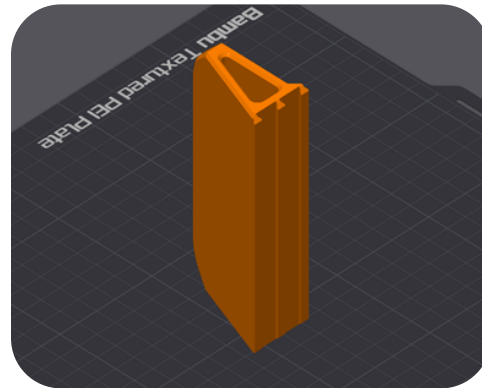

**Dovetail
Laptop Bracket**

Assembly Steps

Step 1:

Assemble the Platform into the Laptop Bracket Wall. Use the two Platform Screws to securely connect the two parts together.



Step 2:

Place the Bracket assembly under the desk shelf dowels. Use three Top Clamps and Top Clamp Screws to securely attach the Bracket to your desk shelf. Use the optional Top Screw Caps to conceal the Top Screw heads. Repeat steps for the second Laptop Bracket.

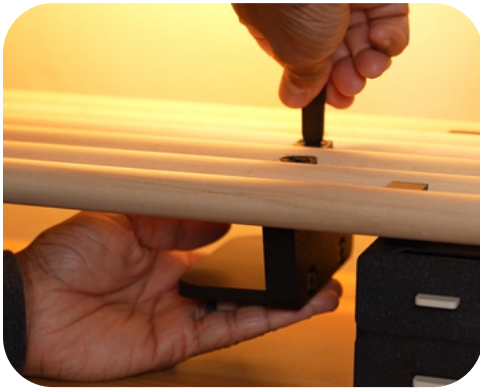

Dovetail Laptop Bracket

If using the Dovetail Laptop Bracket, first install an End Stop onto your Desk Shelf Leg. Then install the Dovetail Laptop Bracket to match the height and position of the hanging Laptop Bracket. Install an additional End Stop afterwards, and snug down both End Stops to fix the Bracket in place.

VERTICAL LAPTOP STAND



Standard



Side-Facing

The vertical laptop stand holds your laptop in the closed position, and comes in two configurations and three sizes per configuration. The two configurations include the Standard Base and the Side Facing Base. The Standard Base stores devices in line with the dowels, while the Side Facing Base stores devices perpendicular to the dowels. There is also an XL size which has taller walls (3 inch height vs original 2 inch height).

Both bases use the same Wall attachments. The Standard Base comes with an integrated front wall, while the Side Facing Base requires printing an End Wall separately. The Side Facing Base comes in two parts, the base and the positioning grooves are printed separately.

There are three walls to choose from. The End Wall is angled, and is best for either end of the Base. One End Wall has a cutout for storing the Key for convenience. The Middle Wall is flat on both sides, and can be used between devices on the Base. Each wall requires two Screws and two Screw Heads.

File Path:

Desk Shelf STL Pack > Attachments > Laptop Stand - Vertical

Print Orientation:

Tree supports are required on the Standard Base and the Side Facing Base as shown below. The End Walls and Middle Wall are printed vertically and require a full brim.

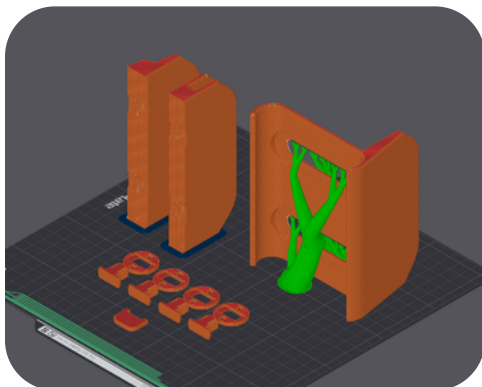

Standard Base
(Medium Size Shown)

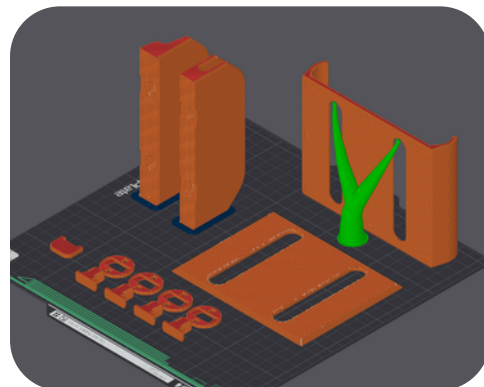

Side Facing Base
(Medium Size Shown)

Size Chart

Below are the largest widths that can be accommodated for each size of the Vertical Laptop Stand Base. (For the Side-Facing Base, the max width is achieved by using one End Wall and one Middle Wall.)

For multi-device setups using Middle Walls, subtract the Middle Wall thickness of 0.625in (15.9 mm) from the max width as necessary.

SIZE	MAX WIDTH (in)	MAX WIDTH (mm)
SMALL	0.8	20
MEDIUM	2.2	55
LARGE	3.6	91

Assembly Steps

Step 1:

Assemble all Screws into the Screw Heads. There should be a light friction fit, and the top of the Screw should be flush with the Screw Head.



Step 2: If using the Standard Base, skip to Step 3.

For the Side-Facing Base, glue the Groove Plate onto the Side-Facing Base. Apply a small drop of glue into each of the cutouts at the bottom of the Groove Plate. Place the Groove Plate on top of the Base and the cutouts should position the plate in the correct location. Ensure the glue is dry before proceeding.



Step 3:

Install the desired number of walls at the desired locations using two screws for each wall. Use the Wide Key to snugly tighten down each screw.

Ensure the grooves of the Walls line up with the grooves of the Base as you tighten the Screws. If you printed the End Wall - Key Storage, you can store the Key in the cutout for safe keeping.

Finally, install the mount onto your Desk Shelf.



DRAWERS



The Drawers folder in the STL pack have a large variety of sizes that can be added to your desk shelf. Glue is required to connect the Rail Mount to the Cubby.

File Path:

Desk Shelf STL Pack > Attachments > Drawers

Print Orientation:

All the different configurations of the drawers, cubbies, and lids use the print orientation shown below.

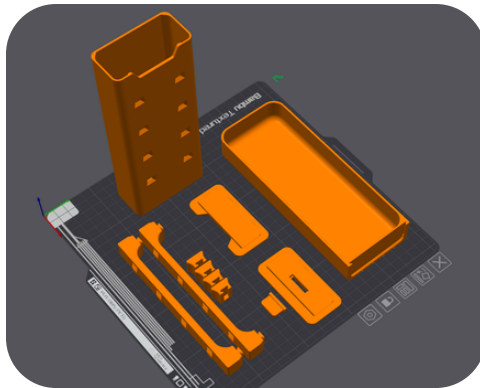

Finding & Understanding Your Print Files

The files are organized in three levels:

Level 1, Shelf Size: Start by opening either the Large Shelf (6-dowel) or Small Shelf (5-dowel) folder.

Level 2, Shelf Height: Inside, you'll find folders for each shelf height. Open the folder that matches your shelf.

Level 3, Component Type: Inside each height folder you'll find three sub-folders: Cubbies, Drawers, and Lids.

Understanding the File Names

Once you're inside a component folder, every file follows the same format:

Width x Height – Configuration

For example: 6W x 1.5H - Single.stl

6W – the width of the cubby or drawer, in inches

1.5H – the interior height of the drawer, in inches

Single – the cubby configuration (see next page)

Cubby Configurations

Cubbies are the housings that the drawers slide into. There are four configurations:

Single: A single cubby for one drawer.

Double: Two drawer cubbies of the same size stacked on top of each other.

Double + Side 3W: A double cubby with an additional 3-inch wide single cubby attached to the side.

Double + Side 6W: Same as above, but with a 6-inch wide side cubby.

Drawers

The height in the file name tells you the interior depth of the drawer. Match the width and height to the cubby you're using.

Lids

Lids are the front covers that you pull to open a drawer. Every lid comes in two styles:

Finger — A slot at the top of the lid that you slip a finger into to pull the drawer open.

Handle — A protruding handle on the front of the lid. If you choose the Handle lid, you'll also need to print the Handle.stl file, which is located in the main Drawers folder (one level above the shelf folders). One handle file works for all sizes.

Match the lid's width and height to the drawer you're using.

Rail Attachments

Inside each shelf folder (Large Shelf and Small Shelf), you'll find a Rail Mount file. This part is glued to the drawer cubby, the drawer system to your shelf.

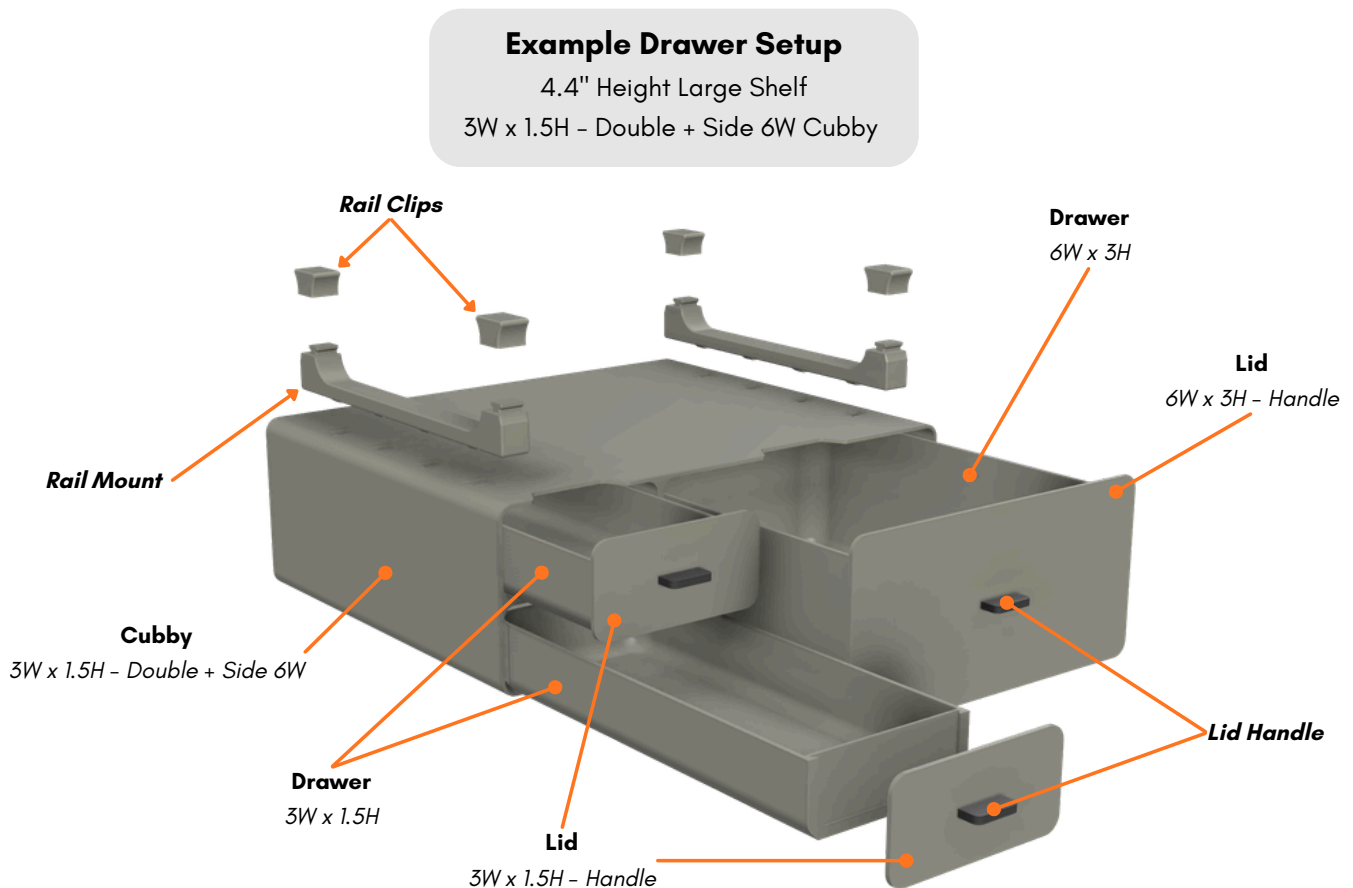

Assembly Steps

Step 1:

All drawer systems of different sizes will be assembled in the same manner shown below. The Front Cover slides into the front groove on the Drawer. There are two styles of the Front Cover, one has a finger cutout, and one has a small handle.



Finger Cutout Cover

Handle Cover

Step 2:

Each drawer uses two rail attachments that hold the Cubby of the drawer system to the dowels. Add glue at the interior corner of the wedge on the Rail Attachments, as shown below. Press the Cubby and Rail Attachments flush together.

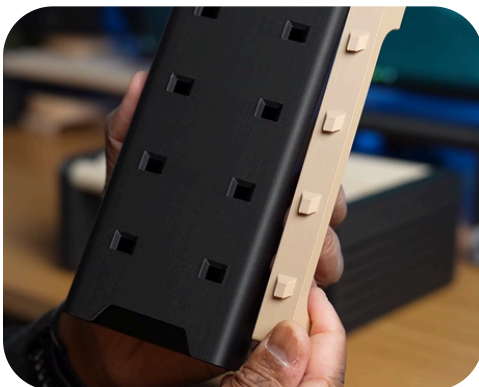

Step 3:

Once the glue dries, use the small Clips to connect the cubby to your desk shelf as shown below.



TWIST-LOCK SYSTEM



The Twist-Lock System currently has a few compatible mounts

- Pencil Cup (1.2in inside diameter x 3.5in height)
- Cup Holder (3.8in inside diameter x 1.5in height)
- Can Holder (2.7in inside diameter x 1.5in height)
- Coaster (3.9in diameter).
- Sticky Notes Holder (for 3x3 inch sticky notes)



The base simply snaps onto the desk shelf dowels, and the attachments twist and lock onto the base. The sticky notes have an unique base that has a flat area specifically for setting down sticky notes (optional). All mounts work with both bases.

File Path:

Desk Shelf STL Pack > Attachments > Twist Lock

Print Orientation:

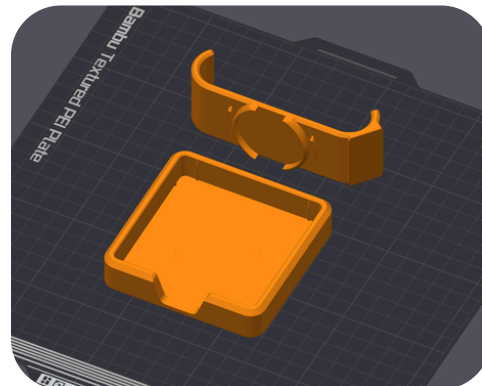
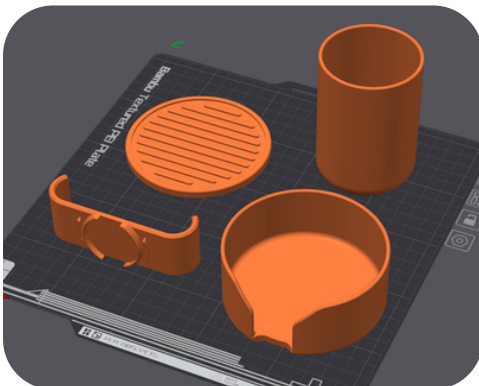

CABLE ORGANIZERS



There are two types of cable holders in the STL pack.

The Cable Clips are simple clips that snap on to a single dowel can organize and route cables along the dowels. They come in two sizes, one for smaller cables, and one for larger cables.

The Straight Cable Clips are a three piece design which use two dowel mounts, and an interchangeable cable guide in the center which can hold 1x, 3x, or 5x cables.

The Dovetail Cable Ducts and Single Cable Holders are held in place using Dovetail End Stops found here: [Desk Shelf STL Pack > Attachments > Dovetail Stops](#). Use a full brim when printing the tall Dovetail Cable Ducts.

To assemble the Straight Cable Clip, simply slide one Dowel Mount onto either side of the desired cable Guide. These snap into place. When installing the straight cable guides onto the desk shelf, press on the Dowel Mount portion of the assembly.

File Path:

[Desk Shelf STL Pack > Attachments > Cable Holders](#)

Print Orientation:

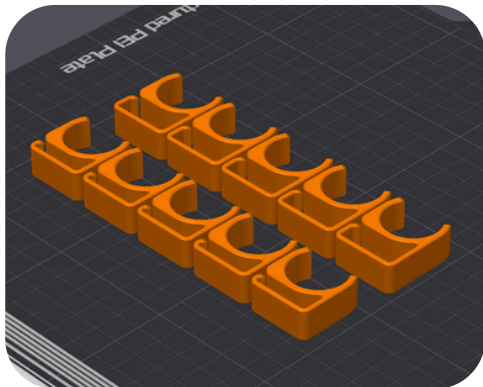

Cable Clip

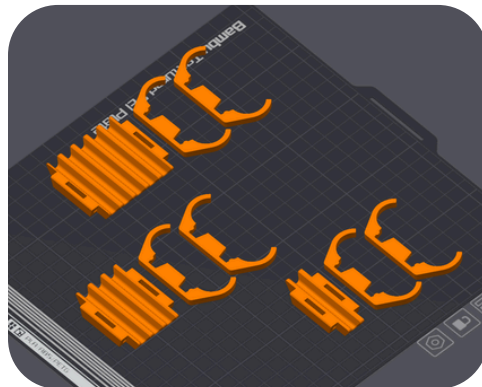

Straight Cable Clip

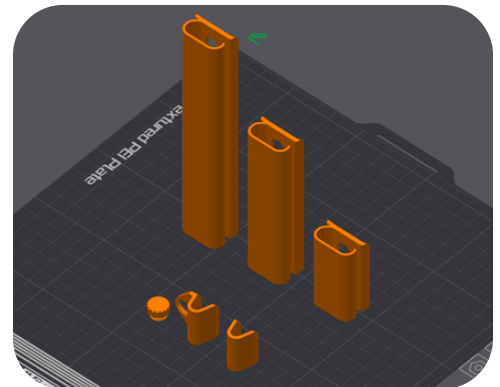

Dovetail Cable Holders



BOOKENDS



The Bookend is a simple 1-inch wide single piece mount that snaps onto your dowels to keep your books in place.

File Path:

Desk Shelf STL Pack > Attachments > Bookend

Print Orientation:

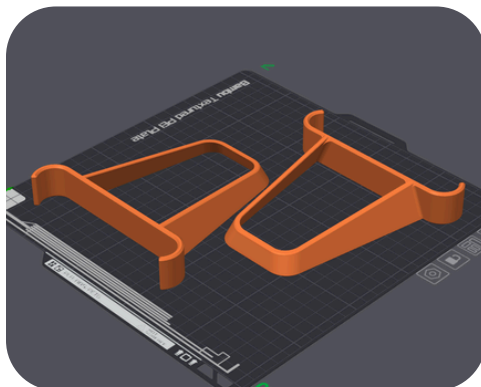

WATCH CHARGER



The Watch Charger add-on comes in two sizes, and each size has different supported chargers.

Small Base Supported Chargers

- Apple Watch Charger
- Samsung Galaxy EP-OR900 Watch Charger
- Google Pixel Watch Gen2/Gen 3 Charger

Large Base Supported Chargers

- Samsung Galaxy EP-OR825 Watch Charger
- Google Pixel Watch Gen 1 Charger

The Google Pixel Watch 4 Charger is a single piece mount, and the charger simply snaps into place from below with the cable facing the cable exit area.

All Watch Charger Bases require tree supports, as shown below.

File Path:

Desk Shelf STL Pack > Attachments > Watch Mounts

Print Orientation:

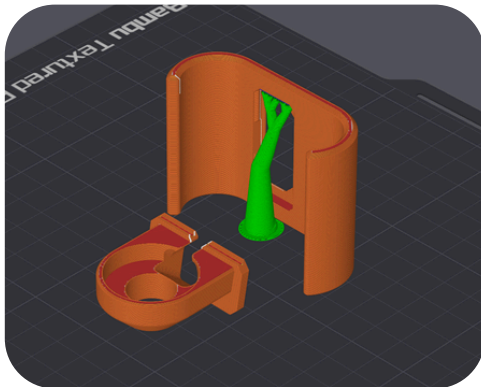

Small/Large Base Chargers

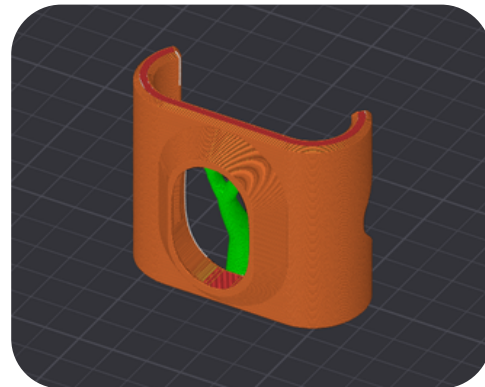

Pixel Watch 4 Charger

Assembly Steps

Step 1:

Insert your charger into the Charger Insert. Slide this part into the Watch Charger Base from the bottom side, as shown below.



Step 2:

The back of the Charger Insert should seat into place, leaving the front edge elevated. Press this elevated section into the Watch Charger Base until it *snaps* into place.



Step 3:

Insert the cable between the two dowels to which you will be mounting. Snap the mount in place.



WATCH STAND



The Watch Stand is a simple single piece mount that snaps onto your dowels and holds any standard watch.

File Path:

Desk Shelf STL Pack > Attachments > Watch Stand.stl

Print Orientation:

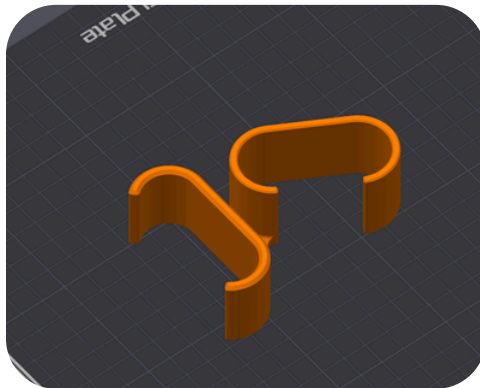

CONTROLLER MOUNT



The video game controller add-on can be configured to hold one or two controllers. For holding a single controller, simply print the Game Controller Base and snap it onto your Desk Shelf. Print all other parts only to add a second elevated controller stand.

The Key is the same model as the ones included in the laptop stand and the speaker stand.

File Path:

Desk Shelf STL Pack > Attachments > Controller Mount

Print Orientation:

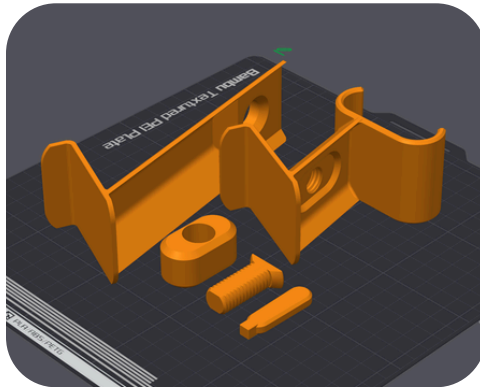

Assembly Steps

Step 1:

Align the Spacer with the back side of the Controller Base.



Step 2:

Align the Second Controller Extension with the Spacer. Then use the Screw to secure the three parts in place.



THREADED ACCESSORY MOUNTS



These mounts are designed around the common 1/4-20 mounting thread available on many peripherals. The first mount in the image above is the Pivoting Captive Screw mount, the second is a simple Captive Screw mount, and the last is a Captive Nut mount.

The Captive Screw mounts are designed around a 1/4-20 captive screw with a 16mm overall length*. The Captive Nut mount uses a standard 1/4-20 hex nut* (7/16" hex, 7/32" thick).

[*Up-to-date links can be found on the website product listing.](#)

File Path:

Desk Shelf STL Pack > Attachments > Threaded Mounts

Print Orientation:

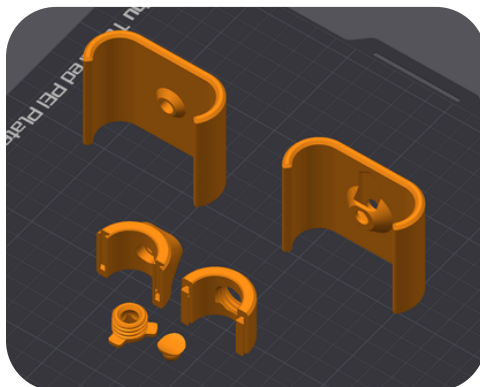

Assembly Steps

The Captive Screw and Captive Nut mounts are straightforward and only require installing the captive screw, and hex nut respectively. Below are the instructions for assembling the Pivoting Captive Screw Mount.

Step 1:

Press the Screw Insert into the Screw. The Screw Insert should be able to rotate freely inside the screw. Install this screw assembly into the Pivot Mount Bottom Half until the Screw Insert is flush with the inside radius of the Bottom Half.





Step 2:

Install the captive screw into the Top Half and mount your peripheral of choice.



Step 3:

Place the Top Half on the front dowel of your Desk Shelf. Then slide the Bottom Half onto the opposite side, ensuring that both dovetail grooves align between both parts. There will be an audible *snap* into place.

Finally, tighten the Screw on the Bottom Half to fix the mount in place.



GLASSES HOLDER



The Glasses Holder is a simple 1-inch wide single piece mount that snaps onto your dowels that holds your eyewear.

File Path:

Desk Shelf STL Pack > Attachments > Glasses Holder.stl

Print Orientation:



DESKRAIL SYSTEM ADAPTERS



These adapters allow DeskRail mounts work with the Desk Shelf STL Pack.

The DeskRail is a modular rail system for mounting chargers, tablet stands, cable organizers, Stream Decks, and more, directly to any desk shelf. These DeskRail adapters unlock a larger library of modular mounts and expand what your Desk Shelf can do.

[Learn more about the DeskRail STL Pack here.](#)

Most mounts use one rail towards the front of the desk shelf, but if you would like to use the DualRail attachments, you will need to assemble the second DualRail towards the back.

File Path:

Desk Shelf STL Pack > Attachments > DeskRail Adapters

Print Orientation:

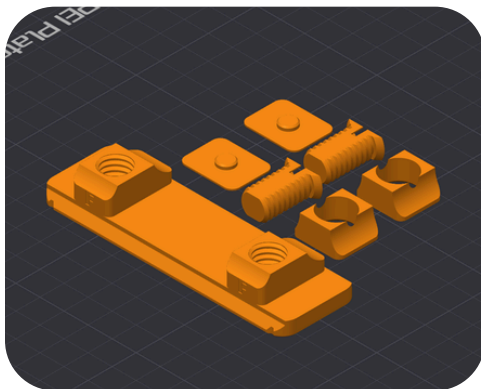

Standard DeskRail
(4 inch)

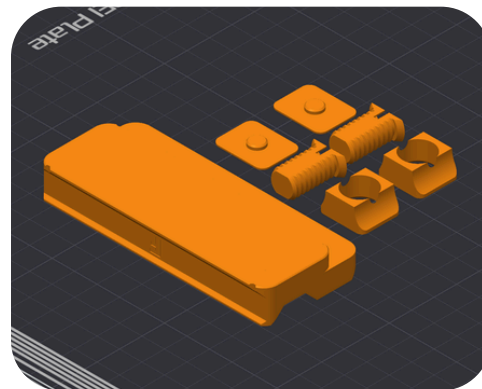

Rear DualRail
(4 inch)



Assembly Steps

Step 1:

To use the standard DeskRail adapter, place the Rail underneath and in between the first and second dowels of your Desk Shelf. The front of the Rail will have a small “F” engraved on the mounting points, which should face forward.



Step 2:

Place one Top Clamp above each of the mounting points on the top side of the dowels. Insert the Mounting Screw through the Top Clamp and fasten into the DeskRail Adapter. Press the optional Screw Caps onto the Screws for a clean surface finish.



Step 3:

To install the rear DualRail adapter, place the Rail geometry underneath the fourth dowel of your DeskShelf. The front of the DualRail also has an engraved "F" which should be facing forward. When placed correctly, the mounting points for the screws will be between the fourth and fifth dowel.

Repeat Step 2 to mount the DualRail using the Top Clamps, Mounting Screws, and optional Screw Caps.

Note: When installing DualRail mounts, you may need to loosen the mounting screws of the rear rail as the dowels can affect the positioning. Once the DualRail mount slides on, you can tighten the mounting screws once again.



BAMBU LED LAMP MOUNT



This design is similar to the MagSafe Mounts, but instead holds the Bambu LED Lamp MH001. This allows you to mount the light puck to the back of your desk shelf and add some accent lighting to your workspace.

[See the MagSafe Mount for assembly instructions.](#)



File Path:

Desk Shelf STL Pack > Attachments > Bambu LED Lamp Mount

Print Orientation:

